

# General Specifications

## EJX910A Multivariable Transmitter



GS 01C25R01-01EN

[Style: S2]

The high performance EJX910A multivariable transmitter features multi-sensing technology with a single-crystal silicon resonant sensor that outputs the measured differential pressure, static pressure and process temperature, which covers multiple protocols: HART, FOUNDATION fieldbus and RS485 Modbus.

Additionally the HART protocol and FOUNDATION fieldbus protocol types are suitable to measure dynamically calculated and fully compensated mass flow for liquid, gas, or steam. 4 to 20 mA DC signal output is available in HART protocol type.

FDT/DTM\* standard conforming software is available for transmitter configuration. FSA120 (FlowNavigator®) is used for flow configuration of the HART protocol and FOUNDATION fieldbus protocol types.

\*: FDT (Field Device Tool): Defines the system environment in which the DTM runs.  
DTM (Device Type Manager): The application which defines the graphical user interface (GUI) specific to the device.

### Key features:

#### [HART protocol type]

- 1.0% mass flow rate accuracy over 1:10 flow range (In case of uncalibrated differential producer (Orifice))
- HART7: Orifice, Nozzle, Venturi, Multiport Averaging Pitot and Cone meters primary devices are supported
- HART5: Orifice, Nozzle and Venturi primary devices are supported
- Advanced diagnostic function (option)
- Simultaneous dual output of 4 to 20mA and pulse signals.
- HART protocol revision selectable from 5 (HART 5) or 7 (HART 7)
- Long tag supporting up to 32 characters (HART 7)
- Enhanced burst mode and event notification(HART 7)
- SIL2 for safety requirement  
Note: HART 5 stands for HART protocol revision 5  
HART 7 stands for HART protocol revision 7

#### [FOUNDATION Fieldbus protocol type]

- 1.0% mass flow rate accuracy over 1:10 flow range (In case of uncalibrated differential producer (Orifice))
- Orifice, Nozzle and Venturi primary devices are supported
- Advanced diagnostic function (option)
- Various function blocks available; 5 AIs, AR, IT, SC, and IS as standard. PID as an optional feature.
- Cyclically displays up to 10 variables
- Software download function (option)

#### [Modbus protocol type]

- RS485 Modbus protocol type provides easy multi-sensing data transmission to the flow computers.
- The process data status is provided for each measured differential pressure, static pressure and process temperature. It is easy to implement process data diagnosis.
- Cyclically displays up to 16 variables including RTU management data.



- Up to 32 transmitters can be connected by multi-drop communication.
- 32 characters long tag and squawk are supported for easy identification of transmitters.

## STANDARD SPECIFICATIONS

### SPAN AND RANGE LIMITS

#### Differential Pressure (DP)

Measurement Span/Range		kPa	inH <sub>2</sub> O (/D1)	mbar (/D3)	mmH <sub>2</sub> O (/D4)
L	Span	0.1 to 10	0.4 to 40	1 to 100	10 to 1000
	Range	-10 to 10	-40 to 40	-100 to 100	-1000 to 1000
M	Span	0.5 to 100	2 to 400	5 to 1000	50 to 10000
	Range	-100 to 100	-400 to 400	-1000 to 1000	-10000 to 10000
H	Span	2.5 to 500	10 to 2000	25 to 5000	0.025 to 5 kgf/cm <sup>2</sup>
	Range	-500 to 500	-2000 to 2000	-5000 to 5000	-5 to 5 kgf/cm <sup>2</sup>

#### Static Pressure (SP)

##### Absolute Pressure

Measurement Span/Range		MPa abs	psia (/D1)	bar abs (/D3)	kgf/cm <sup>2</sup> abs (/D4)
L	Span	1 to 16	145 to 2300	10 to 160	10 to 160
	Range	0 to 16	0 to 2300	0 to 160	0 to 160
M H	Span	1 to 25	145 to 3600	10 to 250	10 to 250
	Range	0 to 25	0 to 3600	0 to 250	0 to 250

Gauge Pressure (Sealed gauge)

Measurement Span/Range	MPa	psi (/D1)	bar (/D3)	kgf/cm <sup>2</sup> (/D4)
L	Span	1 to 16	145 to 2300	10 to 160
	Range	-0.1 to 16	-14.5 to 2300	-1 to 160
M H	Span	1 to 25	145 to 3600	10 to 250
	Range	-0.1 to 25	-14.5 to 3600	-1 to 250

External Temperature (ET) (Pt100 ohm)

Measurement External Temperature Span/Range	°C	°F	K	
L M H	Span	10 to 1050	18 to 1890	10 to 1050
	Range	-200 to 850	-328 to 1562	73 to 1123
Fixed Temperature	-273 to 1927	-459 to 3500	0 to 2200	

□ PERFORMANCE SPECIFICATIONS

Zero-based calibrated span output, and silicone oil, unless otherwise mentioned.  
For FOUNDATION Fieldbus and Modbus protocol types, use calibrated range instead of span in the following specifications.

Specification Conformance

EJX series ensures specification conformance to at least  $\pm 3\sigma$ .

Mass Flow (For Measurement Function Code B of HART and FOUNDATION Fieldbus protocol types)

**Mass Flow Reference Accuracy**  
 $\pm 1.0\%$  of Mass Flow Rate over 10:1 flow range (100:1 DP range) for liquids and gases.

**Totalized Mass Flow Reference Accuracy**  
1.0% of Total Mass Flow.

Note: Assume 100:1 DP range for liquids and gases.

Conditions for mass flow accuracy

- (1) Auto compensation mode.
- (2) M and H capsule
- (3) Uncalibrated differential producer (Orifice) installed based on the following standards. \*1
- (4) Uncertainties for discharge coefficient, primary device bore, pipe diameter, and gas expansion factor defined on following standards. \*1
- (5) Density uncertainty less than 0.1%.

\*1: Standards: ISO5167-1 1991, ISO5167-2 2003, ASME, MFC-3M 1989, AGA No.3 1992

Differential Pressure (DP)

**Reference Accuracy of Calibrated Span (Includes terminal-based linearity, hysteresis, and repeatability)**

Measurement span	H	
Reference accuracy	X $\leq$ span	$\pm 0.04\%$ of Span
	X > span	$\pm(0.005+0.0049 \text{ URL}/\text{span})\%$ of Span
X	70 kPa (280 inH <sub>2</sub> O)	
URL (upper range limit)	500 kPa (2000 inH <sub>2</sub> O)	

Measurement span	M	
Reference accuracy	X $\leq$ span	$\pm 0.04\%$ of Span
	X > span	$\pm(0.005+0.0035 \text{ URL}/\text{span})\%$ of Span
X	10 kPa (40 inH <sub>2</sub> O)	
URL (upper range limit)	100 kPa (400 inH <sub>2</sub> O)	

Measurement span	L	
Reference accuracy	X $\leq$ span	$\pm 0.04\%$ of Span
	X > span	$\pm(0.015+0.005 \text{ URL}/\text{span})\%$ of Span
X	2 kPa (8 inH <sub>2</sub> O)	
URL (upper range limit)	10 kPa (40 inH <sub>2</sub> O)	

**Ambient Temperature Effects per 28°C (50°F) Change**

Capsule	Effect
H	$\pm(0.04\% \text{ Span} + 0.0125\% \text{ URL})$
M	$\pm(0.04\% \text{ Span} + 0.009\% \text{ URL})$
L	$\pm(0.055\% \text{ Span} + 0.09\% \text{ URL})$

**Static Pressure Effects per 6.9 MPa (1000 psi) Change**

**Span Effects**  
L, M and H capsules  
 $\pm 0.075\%$  of span

**Effect on Zero**

Capsule	Effect
H	$\pm 0.028\% \text{ URL}$
M	$\pm 0.02\% \text{ URL}$
L	$\pm 0.05\% \text{ URL}$

**Overpressure Effects**

Overpressure condition: up to maximum working pressure

M and H capsules  
 $\pm 0.03\%$  of URL

**Stability (All normal operating condition, including overpressure effects)**

M and H capsules  
 $\pm 0.1\%$  of URL per 15 years

**Static Pressure (SP)**

**Reference Accuracy of Calibrated Span for Absolute pressure**

**(Includes terminal-based linearity, hysteresis, and repeatability)**

Capsule	Reference accuracy
L, M, H	$\pm 0.1\%$ of span

Note: Gauge pressure reference is 1013.25 hPa (1 atm) The gauge pressure variable is based on the above reference accuracy and can be affected by changes in the atmospheric pressure.

**Ambient Temperature Effects per 28°C (50°F) Change**

Capsule	Effect
M, H	$\pm 0.08\% \text{ Span} \pm 0.018\% \text{ URL}$
L	$\pm 0.08\% \text{ Span} \pm 0.028\% \text{ URL}$

**External temperature (ET)**

**Accuracy (Includes terminal-based linearity, hysteresis, and repeatability)**

Capsule	Accuracy
L, M, H	±0.5°C (±0.9°F)

Specification for External temperature is the transmitter portion only. Sensor errors caused by the RTD are not included. The transmitter is compatible with any Pt100 RTD conforming to IEC 751. Input/output signal is non-isolated.

**Ambient Temperature Effects per 28°C (50°F) Change**

Capsule	Effect
L, M, H	±0.5°C (±0.9°F)

**Power Supply Effects (HART protocol type)**  
±0.005 % per Volt (from 21.6 to 32 V DC, 350Ω)

**Vibration Effects**

Signal	Effect
Differential Pressure	±0.1% of URL
Static Pressure	±0.1% of URL
External Temperature	±0.5°C (±0.9°F)

**Amplifier housing code 1:**  
When tested per the requirements of IEC60770-1 field or pipeline with high vibration level (10-60 Hz, 0.21 mm displacement/60-2000 Hz 3 g)

**Amplifier housing code 2:**  
When tested per the requirements of IEC60770-1 field with general application or pipeline with low vibration level (10-60 Hz 0.15mm displacement /60-500 Hz 2g)

**Mounting Position Effects**

Rotation in diaphragm plane has no effect. Tilting up to 90 degree will cause zero shift up to 0.4 kPa (1.6 inH<sub>2</sub>O) which can be corrected by the zero adjustment.

**Response Time**

Signal	Capsule	HART	Fieldbus*1	Modbus
Differential Pressure	L	230 ms	300 ms	230 ms
	M, H	200 ms	300 ms	200 ms
Static Pressure	L, M, H	200 ms	300 ms	200 ms

When amplifier damping is set to zero and including dead time.

\*1: Output from transducer block.

**FUNCTIONAL SPECIFICATIONS**

**Output specifications for HART Protocol Type Output**

Dual output (Both analog and pulse/contact outputs can be obtained simultaneously. See "Wiring Example for Analog Output and Status/Pulse Output").

**HART Protocol Revision**

HART protocol revision can be selected from 5 or 7 when ordering.

The protocol revision can be changed by user configuration.

The HART protocol revision at the time of shipment is shown by the last number at the serial number column of the name plate.

**Analog Output**

Two wire 4 to 20 mA DC output, user-selectable for Differential Pressure, Static Pressure, External Temperature or Flow Rate signal.

Output range: 3.8 mA to 21.6 mA.

Digital HART FSK protocol are superimposed on the 4 to 20 mA signal.

**Failure Alarm**

Analog output status at CPU failure and hardware error;

Up-scale: 110%, 21.6 mA DC or more (standard)

Down-scale: -2.5%, 3.6 mA DC or less

Analog output status at process abnormality (Option code /DG6);

The result of process abnormality detected by the advanced diagnostic function can be reflected to an analog alert status. The following three setting modes are available.

		Mode		
		Burnout	Fall back	Off
Standard		110%, 21.6mA or more	Holds to a specified value within the output range from 3.8mA to 21.6mA	Normal output
Option Code	/C1	-1.25%, 3.8mA or less		
	/C2	-1.25%, 3.8mA or less		
	/C3	103.1%, 20.5mA or more		

**Pulse/Contact Output**

Pulse or status output is selected by parameter setting.

Transistor contact output (sink type).

Contact rating: 10.5 to 30 V DC, 120 mA DC max.

Low level: 0 to 2 V DC. (See figure below for high and low levels (pulse output).)

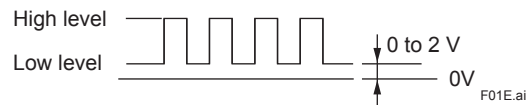

**Pulse Output**

Scaled pulse or frequency pulse output is selectable by parameter setting.

- **Scaled Pulse Output Function**  
Pulse is output by the unit of the scaled flow rate. Scaled pulse can be totalized.
- **Frequency Output Function**  
Number of pulses output per second at 100% of output.  
Pulse frequency: Max. 10 kHz  
Duty cycles: Approx. 50% (1:2 to 2:1)

**Contact Output Function**

High or low alarm

Status signal output mode can be reversed (ON/OFF).

**Signal Output**

Output	Flow rate*1	Differential pressure	Static pressure	External temperature	Total flow*1
4-20mA	✓*3	✓*2	✓	✓	
Pulse output	✓				✓
High/Low alarm	✓	✓	✓	✓	

- \*1: When Measurement function code B is specified.
- \*2: Square root output is not available. Low cut linear mode is not supported.
- \*3: Reversed output is not available.

**Output specifications for FOUNDATION Fieldbus Protocol Type**

**Output**

Digital communication signal based on the FOUNDATION fieldbus specification.

**Functional Specifications**

Functional specifications for Fieldbus communication conform to the standard specification (H1) of FOUNDATION fieldbus.

**Function Block**

Block name	Number	Execution time	Note
AI	5	30 ms	For flow, differential pressure, static pressure, external temperature and capsule or amplifier temperature.
SC	1	30 ms	An output of Signal characterizer block is a nonlinear function of the respective input. The function is determined by a table.
IT	1	30 ms	Integrator block intergrates a variable as a function of the time of accumulates the counts.
IS	1	30 ms	Input Selector block provides selection of up to eight inputs and generate an output based on the configured action.
AR	1	30 ms	Arithmetic block allows simple use of popular measurement math functions.
PID	1	45 ms	Applicable when /LC1 option is specified.

**LM Function**

LM function is supported.

**Output specifications for Modbus Protocol Type**

Item	Description
Communication protocol	2-wire half duplex RS-485 Modbus
Flow control	None
Baud rate	1200, 4800, 9600*, 19200
Start bit	1 bit (Fixed)
Stop bit	1 bit*, 2 bits
Parity bit	Odd, Even, None*
Transfer mode	RTU (Remote Terminal Unit) Data length: 8 bits LSB (Least significant bit sent first)
Slave address	1* to 247

Item	Description
Support function	1: Read Coils
	2: Read Discrete Inputs
	3: Read Holding Registers
	4: Read Input Register
	5: Write Single Coil
	8: Diagnostic (00: Return Query Data)
	16: Write Multiple registers
Bus termination	43: Read device Identification
	Standard RS-485 bus termination ON (bus end), OFF* (not bus end)

\*: Factory default setting

**Advanced Diagnostics (option for HART and FOUNDATION Fieldbus protocol types)**

- Impulse line blockage detection  
The impulse line condition can be calculated and detected by extracting the fluctuation component from the differential pressure and static pressure signals. Also EJX910A detects the impulse line abnormality particularly which side of impulse line is plugged.
- Heat trace monitoring  
The change of the flange temperature calculated by using the two temperature sensors built in the EJX910A enables to detect the heat trace breakage or the abnormal temperature due to the failure.

**Damping Time Constant (1st order)**

Amplifier damping time constant is adjustable from 0.00 to 100.00 seconds and added to response time, applicable independently for “DP, SP, ET, and flow” for HART, FOUNDATION fieldbus and “DP, SP, and ET” for Modbus.

**Update Period**

Signal	HART	Fieldbus	Modbus
Flow rate	100 ms	200 ms	—
Differential pressure	100 ms	200 ms	100 ms
Static pressure	100 ms	200 ms	100 ms
External temperature	400 ms	800 ms	400 ms
Total flow	1000 ms	—*	—

\*: Output from IT function block.

**Zero Adjustment Limits**

Zero can be fully elevated or suppressed, within the lower and upper range limits of the capsule, applicable for DP, SP, and ET independently.

**External Zero Adjustment**

External zero for DP is continuously adjustable with 0.01% incremental resolution of span.

**Integral Indicator (LCD)**

5-digit (Flow, DP, SP, and ET) or 6-digit (Total flow) numerical display, 6-digit unit display and bar graph. The indicator is configurable to display one or up to four variables periodically.

For FOUNDATION Fieldbus, the indicator is configurable to display up to 10 function block output values.

For Modbus, the indicator is configurable to display up to 16 output values including RTU output.

**Burst Pressure Limits**

69 MPa (10000 psi)



**Self Diagnostics**

CPU failure, hardware failure, configuration error, process alarm for differential pressure, static pressure and external temperature.

**SIL Certification**

EJX series transmitters except FOUNDATION Fieldbus and Modbus protocol types are certified by TÜV in compliance with the following standards; IEC 61508: 2010; Part1 to Part 7 Functional Safety of electrical/electronic/programmable electronic safety-related systems; SIL 2 capability for single transmitter use, SIL 3 capability for dual transmitter use.

**Functions Applicable for HART Protocol Revision 7**

- Long tag supporting up to 32 characters  
Long tag secures a better asset management with abundant digits in its software.
- Enhanced burst mode and event notification  
Advanced burst mode includes the variety of transmission setting by specifying burst variables, update period, and message trigger mode, and event notification function gives you alert signal based on the status change in preset values and self-diagnosis.
- Squawk  
Identifying the transmitter by displaying the particular pattern on LCD
- Multidrop communication  
Up to 63 transmitters can be connected. An analog signal output available for one device in a loop.

**Functions Applicable for Modbus Protocol**

- Process data diagnosis  
The process data status is provided for each measured differential pressure, static pressure and process temperature. Also device status parameter is available for detail diagnosis.
- Long tag supporting up to 32 characters  
Long tag secures a better asset management with abundant digits.
- Squawk  
Identifying the transmitter by displaying the particular pattern on LCD.
- Multi-drop communication  
Up to 32 transmitters can be connected.

**■ Mass Flow Calculation**

(For Measurement function code B of HART and FOUNDATION Fieldbus protocol types)

□ **Auto Compensation Mode (FSA120 FlowNavigator is required for configuration)**

Configuration of the fluid physical properties and primary element for the EJX900 series can be performed using a dialog window of FSA120. All flow factors for mass flow calculation are dynamically compensated to an optimum value. In Auto mode, mass flow can be measured with high accuracy. The flow factors that are automatically compensated are discharge coefficient, diameter of primary device, upstream internal pipe diameter, gas expansion factor, density, and viscosity.

Supported primary devices are different by output signal type.

HART 7 protocol type: Orifice, Nozzle, Venturi, Multiport Averaging Pitot and Cone meters  
HART 5 and FOUNDATION Fieldbus protocol types: Orifice, Nozzle, Venturi

FlowNavigator: FSA120 Flow Configuration Software (refer to GS 01C25R51-01EN). The software package is used to perform mass flow configuration for the EJX910A. These software can also read and write the general parameters of HART communications or FOUNDATION Fieldbus communication. Configuration of the fluid physical properties and the primary element of the EJX900 series can be done by means of a dialog menu.

□ **Basic Flow Calculation Mode**

Flow operation and density compensation are performed conventionally, with the flow factors being input manually.

The operational expression is switched by the fluid type and the unit setting.

Density compensation by phase:

Gas: Compensation as ideal gas by temperature and pressure.

Liquid: Compensation by temperature.

Flow unit categories: See Table 1.

**Table 1. Flow Operational Expression**

Fluid type	Flow unit Category	Flow equation
Liquid	Mass Flow	$Q_m, Q_v \text{ or } Q_{v\_norm} = K_{factor} \times \sqrt{\Delta P} \times (1 + \text{Temp K1} \times (T - T_b))$ *1
	Normal-Standard Volume Flow	$\times \sqrt{\Delta P} \times (1 + \text{Temp K1} \times (T - T_b))$
	Volume Flow	
Gas	Mass Flow	$Q_m \text{ or } Q_{v\_norm} = K_{factor} \times \sqrt{\Delta P \times T_b / T} \times SP / SP_b$ *1
	Normal-Standard Volume Flow	$Q_v = \frac{K_{factor}}{\sqrt{\Delta P \times T / T_b \times SP_b / SP}}$ *1
	Volume Flow	

\*1: — : User setting parameter

T01E.ai

**Table 2. Symbol**

Symbol	Description
Qm	Mass Flow
Qv	Volume Flow
Qv_norm	Normal-Standard Volume Flow
Kfactor	Basic flow Calculation factor
ΔP	Differential Pressure (Transmitter Setting unit)
Tb	Reference temperature unit: K
T	Temperature unit: K
SPb	Reference static pressure unit: kPa abs
SP	Static Pressure unit: kPa abs
Temp K1	The density rate of change per temperature 1degC of a density base value (value which set 100% to 1) For Volume Flow: Set 0

## NORMAL OPERATING CONDITION

(Optional features or approval codes may affect limits.)

### Ambient Temperature Limits

-40 to 85°C (-40 to 185°F)  
 -30 to 80°C (-22 to 176°F) with LCD display

### Process Temperature Limits

-40 to 120°C (-40 to 248°F)

### Ambient Humidity Limits

0 to 100% RH

### Working Pressure Limits (Silicone oil)

Maximum Pressure Limits

L Capsule	16 MPa (2300 psi)
M and H Capsule	25 MPa (3600 psi)

### Minimum Pressure Limit

See figure below.

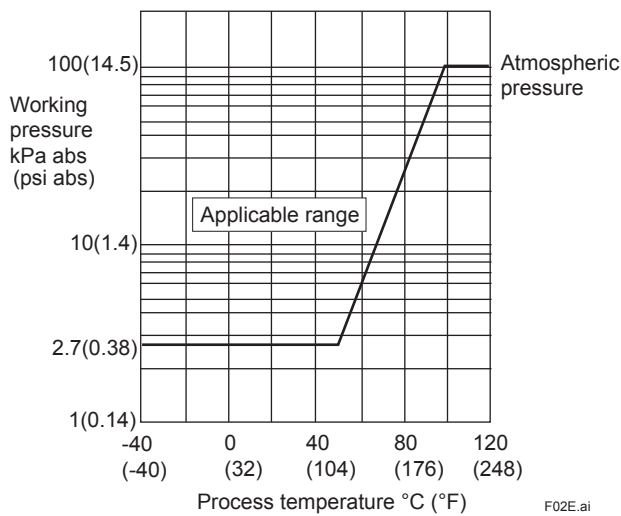

Figure 1. Working Pressure and Process Temperature

### Supply & Load Requirements (for HART protocol type)

(Optional features or safety approvals may affect electrical requirements.)

With 24 V DC supply, up to a 570Ω load can be used. See figure below.

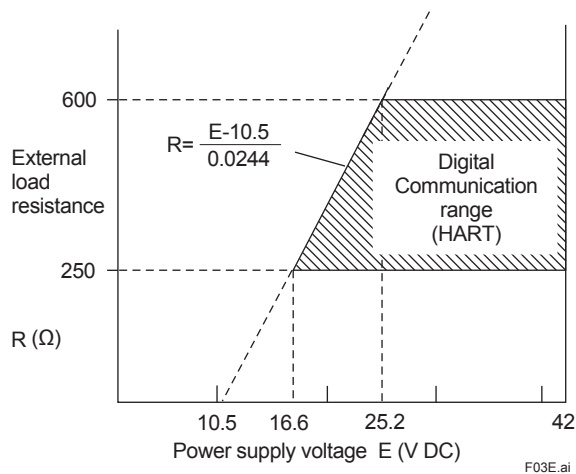

Figure 2. Relationship Between Power Supply Voltage and External Load Resistance

### Supply Voltage

[for HART]

10.5 to 42 V DC for general use and flameproof type.

10.5 to 32 V DC for lightning protector (Option code /A).

10.5 to 30 V DC for intrinsically safe, type n or nonincendive.

Minimum voltage limited at 16.6 V DC for HART communication.

[for FOUNDATION fieldbus]

9 to 32 V DC for general use, flameproof type, Type n or nonincendive.

[for Modbus]

9 to 30 V DC 250 mW for general use and flameproof type, quiescent supply current 10 mA typical

### Load (for HART protocol type)

0 to 1335Ω for operation

250 to 600Ω for digital communication

### FOUNDATION Fieldbus

#### Communication Requirements

Supply Voltage: 9 to 32 V DC

Current draw :

Steady state 15 mA (max)

Software download state 24 mA (max)

### EMC Conformity Standards

EN61326-1 Class A, Table2

EN61326-2-3

EN61326-2-5 (for fieldbus)

### European Pressure Equipment Directive

2014/68/EU

Sound Engineering Practice (for all capsules)

With option code /PE3 (for M and H capsules)

Category III, Module H, Type of Equipment : Pressure

Accessory-Vessel, type of Fluid: Liquid and Gas,

Group of fluid: 1 and 2

### EU RoHS Directive

EN IEC 63000

### Safety Requirement Standards

EN61010-1, EN61010-2-030

C22.2 No.61010-1, C22.2 No.61010-2-030

- Installation category: I  
(Anticipated transient overvoltage 330V)
- Pollution degree: 2
- Indoor/Outdoor use

---

## ■ PHYSICAL SPECIFICATIONS

### Wetted Parts Materials

#### Diaphragm, cover flange, process connector, capsule gasket, and vent/drain plug

See "MODEL AND SUFFIX CODES."

#### Process connector gasket

PTFE Teflon

Fluorinated rubber for option code N2 and N3

### Non-wetted Parts Materials

#### Bolts

B7 carbon steel, 316L SST or 660 SST

#### Housing

- Low copper cast aluminum alloy
- ASTM CF-8M Stainless steel (optional)

#### Coating of housing

[for aluminum housing]

Polyester resin powder coating

Mint-green paint (Munsell 5.6BG 3.3/2.9 or its equivalent)

[for option code /P□ or /X2]

Epoxy and polyurethane resin solvent coating

#### Degrees of protection

IP66/IP67, Type 4X

#### Cover O-rings

Buna-N, fluoro-rubber (optional)

#### Name plate and tag

316 SST

#### Fill fluid

Silicone oil, fluorinated oil (optional)

#### Cable for RTD

External Temperature Input Code -1, -2, -3, -4

Oil-proof and a heat-resistant cable with a shield

Outside diameter: 8.5 mm (0.335 inch),

Voltage rating: 300V

Temperature rating: -40 to 105°C (-40 to 221°F)

Frame resistance: UL (CSA) VW-1

Adaptation standard: UL (CSA) AWM STYLE 2517

External Temperature Input Code -B,-C,-D

A heat-resistant FEP cable with a shield

Outside diameter: 4.3mm (0.168 inch)

Voltage rating: 300V

Temperature rating: -80 to 200°C (-112 to 392°F)

Flame resistance: NEC Article 800-CMP

Adaptation standard: NEC Article 725-PLTC

Note for using an extension cable:

When extending a temperature cable with using an extension cable and a junction box, total cable length including the original external temperature cable must be less than 25 m. Use PE or XLPE insulated cable for extension.

#### Cable gland:

Nickel plating brass

### Weight

2.8 kg (6.2 lb) without integral indicator, mounting bracket, process connector and RTD cable.

Add 1.5 kg (3.3 lb) for Amplifier housing code 2.

### Connections

See "MODEL AND SUFFIX CODES."

Process connection of cover flange: IEC61518

## MODEL AND SUFFIX CODES

Model	Suffix Codes	Description
<b>EJX910A</b>	.....	Multivariable transmitter
Output signal	-E ..... -J ..... -F ..... -M .....	4 to 20 mA DC with digital communication (HART protocol) <sup>*8</sup> 4 to 20 mA DC with digital communication (HART 5/HART 7 protocol) <sup>*9</sup> Digital communication (FOUNDATION fieldbus protocol) Digital communication (RS485 Modbus protocol) When Output signal code -M is selected, option code A must also be selected.
Measurement span (capsule)	L ..... M ..... H .....	0.1 to 10 kPa (0.4 to 40 inH <sub>2</sub> O) 0.5 to 100 kPa (2 to 400 inH <sub>2</sub> O) 2.5 to 500 kPa (10 to 2000 inH <sub>2</sub> O)
Wetted parts material <sup>*1</sup>	S .....	See Table 5.
Process connections	0 ..... 1 ..... 2 ..... 3 ..... 4 ..... ▶ 5 .....	without process connector (Rc1/4 female on the cover flanges) with Rc1/4 female process connector with Rc1/2 female process connector with 1/4 NPT female process connector with 1/2 NPT female process connector without process connector (1/4 NPT female on the cover flanges)
Bolts and nuts material	J ..... G ..... C .....	B7 carbon steel 316L SST 660 SST
Installation	-7 ..... ▶ -8 ..... -9 ..... -B .....	Vertical piping, left side high pressure, and process connection downside Horizontal piping and right side high pressure Horizontal piping and left side high pressure Bottom Process Connection, left side high pressure
Amplifier housing	1 ..... 2 .....	Cast aluminum alloy ASTM CF-8M stainless steel
Electrical connection	F ..... 2 ..... 4 ..... 5 ..... 7 ..... 9 ..... A ..... C ..... D .....	G 1/2 female, two electrical connections (One connection for RTD) 1/2NPT female, two electrical connections (One connection for RTD) M20 female, two electrical connections (One connection for RTD) G 1/2 female, two electrical connections and blind plug <sup>*2*6*7</sup> 1/2NPT female, two electrical connections and a blind plug <sup>*2*6*7</sup> M20 female, two electrical connections and a blind plug <sup>*2*6*7</sup> G 1/2 female, two electrical connections and a 316 SST blind plug <sup>*2</sup> 1/2 NPT female, two electrical connections and a 316 SST blind plug <sup>*2</sup> M20 female, two electrical connections and a 316 SST blind plug <sup>*2</sup>
Integral indicator	▶ D ..... N .....	Digital indicator None
Mounting bracket	B ..... D ..... J ..... K ..... M ..... ▶ N .....	304 SST 2-inch pipe mounting, flat type (for horizontal piping) 304 SST or SCS13A 2-inch pipe mounting, L type (for vertical piping) 316 SST 2-inch pipe mounting, flat type (for horizontal piping) 316 SST or SCS14A 2-inch pipe mounting, L type (for vertical piping) 316 SST or SCS14A 2-inch pipe mounting (for bottom process connection type) None
External temperature input	-0 .... -1 .... -2 .... -3 .... -4 .... -B .... -C .... -D ....	Fixed temperature (without cable) <sup>*5</sup> RTD input with 0.5 m (1.64 ft) of shielded cable and two cable glands <sup>*3 *7 *10</sup> RTD input with 4 m (13.1 ft) of shielded cable and two cable glands <sup>*3 *7 *10</sup> RTD input with 7.5 m (24.6 ft) of shielded cable and two cable glands <sup>*3 *7 *10</sup> RTD input with 25 m (81 ft) of shielded cable and two cable glands <sup>*3 *7 *10</sup> RTD input with 4 m (13.1 ft) of shielded cable without cable gland <sup>*3 *4</sup> RTD input with 7.5 m (24.6 ft) of shielded cable without cable gland <sup>*3 *4</sup> RTD input with 25 m (81 ft) of shielded cable without cable gland <sup>*3 *4</sup>
Measurement function	▶ A ... B ...	Multi Sensing (DP, P and T) Mass Flow Measurement (Flow, DP, P and T) (Applicable for Output signal codes -E, -J, and -F).
Option codes		/□ Optional specification

The “▶” marks indicate the most typical selection for each specification.

\*1: ⚠ Users must consider the characteristics of selected wetted parts material and the influence of process fluids. The use of inappropriate materials can result in the leakage of corrosive process fluids and cause injury to personnel and/or damage to plant facilities. It is also possible that the diaphragm itself can be damaged and that material from the broken diaphragm and the fill fluid can contaminate the user’s process fluids.

Be very careful with highly corrosive process fluids such as hydrochloric acid, sulfuric acid, hydrogen sulfide, sodium hypochlorite, and high-temperature steam (150°C [302°F] or above). Contact Yokogawa for detailed information of the wetted parts material.

\*2: For External temperature input code 0 (Fixed temperature) .

\*3: Recommended External Temperature Input Cable is as shown in Table 4. RTD is not provided.

\*4: Specify when using conduit for RTD connection.

\*5: Preset external temperature value is used for density compensation.

\*6: Material of a blind plug is aluminum alloy or 304 SST.



- \*7: Not applicable for Amplifier housing code 2.
- \*8: Output signal code E: HART 5.
- \*9: Output signal code J: HART 5 or HART 7 selectable. Specify HART 5 or HART 7 when ordering. (Output signal code J is recommended for HART communication.)
- \*10: Refer to table 6 whether the cable glands are attached or not.

**□ Selection guide for HART 5 and HART 7**

Select HART 5 or HART 7 as follow.

Output signal code	Specified item when ordering "HART protocol revision"	HART protocol revision	Selection guide		Note
			Requirement for HART 7 function	Other conditions	
-E	Not Available	HART 5	NO	Not available to switch to HART 7 protocol after delivery.	*
-J	Specify '5'			Available to switch to HART 7 protocol after delivery by user-configuration.	**
		Specify '7'	HART 7	YES In this case, be sure to confirm that HART configuration tool supports HART 7 by Table 3.	Available to switch to HART 5 protocol after delivery by user-configuration.

- \*: This code will be unified to the new code "-J". Therefore the code "-J" is recommended for HART communication type.
- \*\* : Indicate the most typical selection for HART communication. Select this when HART 7 functionality is not required. In case of selecting HART 7 without conforming to Table 3, communication will not be available.

**□ HART protocol revision and communication**

Protocol revision supported by HART configuration tool must be the same or higher than that of the EJX multivariable transmitter.

HART 7 communication is supported by FieldMate R2.02 or later.

**Table 3. HART protocol revision and communication**

		Protocol revision supported by HART configuration tool	
		HART 5	HART 7
Protocol revision of EJX multivariable transmitter	HART 5	Communication Available	Communication Available
	HART 7	Communication Not Available	Communication Available

**□ Applicable External Temperature Cable**

**Table 4.**

External Temperature Input Code		-1, -2, -3, -4	-B, -C, -D
General Application		✓	✓
Factory Mutual (FM)	Explosionproof Approval		✓
	Intrinsically Safe Approval Nonincendive		✓
ATEX	Flameproof Approval	✓	
	Intrinsically Safe Approval	✓	
Canadian Standards Association (CSA)	Explosionproof Approval		✓
IECEX Scheme	Flameproof Approval	✓	✓

**□ Wetted Parts Materials**

**Table 5.**

Wetted parts material code	Cover flange and process connector	Capsule	Capsule gasket	Vent/Drain plug
S#	ASTM CF-8M *1*3	Hastelloy C-276 *2 (Diaphragm) F316L SST, 316L SST (Others)	Teflon-coated 316L SST	316 SST

- \*1: Cast version of 316 SST. Equivalent to SCS14A.
  - \*2: Hastelloy C-276 or ASTM N10276.
  - \*3: Intergranular corrosion test passed according to ASTM A262 Practice E.
- The '# marks indicate the construction materials conform to NACE material recommendations per MR0175/ISO 15156. Please refer to the latest standards for details. Selected materials also conform to NACE MR0103.

□ Attached Cable glands for EJX910A and EJX930A

Table 6.

		Flameproof approval				Intrinsically safe approval			General Application
		FM CSA	ATEX	IECEX Scheme	NEPSI KOSHA INMETRO EAC	FM	ATEX	NEPSI KOSHA INMETRO EAC	
External Temperature Input	-0	No	No	No	No	No	No	N/A	No
	-1, -2, -3, -4	N/A	Yes	Yes	No	N/A	Yes		Yes
	-B, -C, -D	No	N/A	No	No	No	N/A		No

Yes: Attached No: Not attached N/A: Not applicable

■ OPTIONAL SPECIFICATIONS (For Explosion Protected)

Please select appropriate equipment in accordance with the laws and regulations of the relevant country/region, when it is used in a location where explosive atmospheres may be present.

Item	Description	Code
Factory Mutual (FM)	FM Explosionproof Approval *4 Applicable Standard: FM3600:2018, FM3615:2018, FM3810:2018, NEMA 250:2003, ANSI/UL 61010-1:2012, ANSI/UL 61010-2-30:2012 Explosionproof for Class I, Division 1, Groups B, C and D, Dust-ignitionproof for Class II/III, Division 1, Groups E, F and G, in Hazardous locations, indoors and outdoors (Enclosure: Type 4X) "FACTORY SEALED, CONDUIT SEAL NOT REQUIRED." Temperature class: T6, Amb. Temp.: -40 to 60°C (-40 to 140°F)	FF1
	FM Intrinsically Safe and Nonincendive Approval *1 *3 *4 Applicable Standard: FM 3600:2011, FM 3610:2010, FM 3611:2004, FM 3810:2005, ANSI/ISA-60079-0-2009, ANSI/ISA-60079-11-2009, ANSI/ISA-60079-27-2006, ANSI/ISA-61010-1-2004, NEMA 250:1991 Intrinsically Safe for Class I, II, & III, Division 1, Groups A,B,C,D,F & G, Entity, FISCO. Class I, Zone 0, AEx ia IIC, Enclosure: Type 4X, Temp. Class: T4, Amb. Temp.: -40 to 60°C (-40 to 140°F). Intrinsically Apparatus Parameters: [FISCO (IIC)] Ui=17.5 V, li=380 mA, Pi=5.32 W, Ci=3.52 nF, Li=0 μH [FISCO (IIB)] Ui=17.5 V, li=460 mA, Pi=5.32 W, Ci=3.52 nF, Li=0 μH [Entity] Ui=24 V, li=250 mA, Pi=1.2 W, Ci=3.52 nF, Li=0 μH Sensor Circuit: Uo=6.51 V, Io=4 mA, Po=6 mW, Co=34 μF, Lo=500 mH Nonincendive for Class I, Division 2, Groups A, B, C and D, NIFW, FNICO Class I, Zone 2, Group IIC, NIFW, FNICO Class II, Division 2, Groups F&G, and Class III, Division 1 Enclosure: Type 4X, Temp. Class: T4, Amb. Temp.: -40 to 60°C (-40 to 140°F) Nonincendive Apparatus Parameters: Vmax.=32 V, Ci=1.76 nF, Li=0 μH	FS15
ATEX	ATEX Flameproof Approval *4 Applicable Standard: EN IEC 60079-0, EN 60079-1, EN 60079-31 Certificate: KEMA 07ATEX0109 X II 2 G Ex db IIC T6...T4 Gb, II 2 D Ex tb IIIC T85°C Db Degree of protection: IP66/IP67 Amb. Temp. (Tamb) for gas-proof : T4: -50 to 75°C (-58 to 167°F), T5: -50 to 80°C (-58 to 176°F), T6: -50 to 75°C (-58 to 167°F) Process Temp. for gas-proof (Tp): T4: -50 to 120°C (-58 to 248°F), T5: -50 to 100°C (-58 to 212°F), T6: -50 to 85°C (-58 to 185°F) Max. surface Temp. for dust-proof: T85°C (Tamb: -30 to 75°C, Tp: -30 to 85°C) *5	KF22
	ATEX Intrinsically Safe Approval *1 *3 *4 Applicable Standards: EN IEC 60079-0, EN 60079-11 Certificate: KEMA 06ATEX0278X II 1 G Ex ia IIC/IIB T4 Ga, II 2 D Ex ia IIIC T85°C T100°C T120°C Db Type of protection: IP66/IP67 Amb. Temp. for EPL Ga: -40 to 60°C (-40 to 140°F) Amb. Temp. for EPL Db: -30 to 60°C *5 Max. Process Temp. (Tp): 120°C (248°F) Max. Surface Temp. for EPL Db: T85°C (Tp:80°C), T100°C (Tp:100°C), T120°C (Tp:120°C) Ambient Humidity: 0 to 100% (No condensation) Electrical data: Supply/Output circuit (terminals + and -) [FISCO (IIC)] Ui=17.5 V, li=380 mA, Pi=5.32 W, Ci=3.52 nF, Li=0 μH [FISCO (IIB)] Ui=17.5 V, li=460 mA, Pi=5.32 W, Ci=3.52 nF, Li=0 μH [Entity] Ui=24 V, li=250 mA, Pi=1.2 W, Ci=3.52 nF, Li=0 μH External Temperature Input circuit (connector) Uo=7.63 V, Io=3.85 mA, Po=0.008 W, Co=4.8 μF, Lo=100 mH	KS26

Item	Description	Code
Canadian Standards Association (CSA)	CSA Explosionproof Approval *4 Certificate: 2014354 Applicable Standard: C22.2 No.0, C22.2 No.0.4, C22.2 No.0.5, C22.2 No.25, C22.2 No.30, C22.2 No.94, C22.2 No.60079-0, C22.2 No.60079-1, C22.2 No.61010-1, C22.2 No.61010-2-030 Explosion-proof for Class I, Groups B, C and D. Dustignition-proof for Class II/III, Groups E, F and G. When installed in Division 2, "SEAL NOT REQUIRED" Enclosure: Type 4X, Temp. Code: T6...T4 Ex d IIC T6...T4 Enclosure: IP66 and IP67 Max.Process Temp.: T4;120°C (248°F), T5;100°C (212 °F), T6; 85°C (185°F) Amb.Temp.: -50 to 75°C (-58 to 167°F) for T4, -50 to 80°C (-58 to 176°F) for T5, -50 to 75°C (-58 to 167°F) for T6 *5 Process Sealing Certification Dual Seal Certified by CSA to the requirement of ANSI/ISA 12.27.01 No additional sealing required Primary seal failure annunciation: at the zero adjustment screw	CF1
IECEX Scheme	IECEx Flameproof Approval *4 Applicable Standard: IEC 60079-0:2011, IEC60079-1:2007-4 Certificate: IECEx CSA 07.0008 Flameproof for Zone 1, Ex d IIC T6...T4 Gb Enclosure: IP66 and IP67 Max.Process Temp.: T4;120°C (248°F), T5;100°C (212°F), T6; 85°C (185°F) Amb.Temp.: -50 to 75°C (-58 to 167°F) for T4, -50 to 80°C (-58 to 176°F) for T5, -50 to 75°C (-58 to 167°F) for T6	SF2
	IECEx Flameproof Approval *4 Applicable Standard: IEC 60079-0, IEC 60079-1, IEC 60079-31 Certificate: IECEx DEK 14.0046X Enclosure: IP66/IP67 Ex db IIC T6...T4 Gb, Ex tb IIIC T85°C Db Amb. Temp. (Tamb) for gas-proof : T4; -50 to 75°C (-58 to 167°F), T5; -50 to 80°C (-58 to 176°F), T6; -50 to 75°C (-58 to 167°F) Process Temp. for gas-proof (Tp): T4; -50 to 120°C (-58 to 248°F), T5; -50 to 100°C (-58 to 212°F), T6; -50 to 85°C (-58 to 185°F) Max. surface Temp. for dust-proof: T85°C (Tamb: -30 to 75°C, Tp: -30 to 85°C) *5	SF22

Contact Yokogawa representative for the codes indicated as '—'

- \*1: Not Applicable for Output signal codes -E and -J.
- \*2: Not Applicable for Output signal code -F.
- \*3: Not Applicable for Output signal code -M.
- \*4: Applicable for Electrical connection codes 2, 4, 7, 9, C, and D.
- \*5: Lower limit of ambient temperature is -15°C (5°F) when option code HE is specified.

**OPTIONAL SPECIFICATIONS**

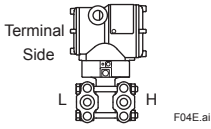
Item		Description	Code
Painting	Color change	Amplifier cover only <sup>*20</sup>	P□
	Coating change	Amplifier cover and terminal cover, Munsell 7.5 R4/14 Anti-corrosion coating <sup>*1*20</sup>	PR X2
316 SST exterior parts		316 SST zero-adjustment screw and setscrews <sup>*15</sup>	HC
Fluoro-rubber O-ring		All O-rings of amplifier housing. Lower limit of ambient temperature: -15°C (5°F)	HE
Lightning protector		HART protocol type: Transmitter power supply voltage: 10.5 to 32 V DC Allowable current: Max. 6000 A (1×40 μs), Repeating 1000 A (1×40 μs) 100 times Applicable Standards: IEC 61000-4-4, IEC 61000-4-5 FOUNDATION fieldbus protocol type: Allowable current: Max. 6000 A (1×40 μs), Repeating 1000 A (1×40 μs) 100 times Applicable Standards: IEC 61000-4-4, IEC 61000-4-5 Modbus protocol type: Applicable Standards: IEC 61000-4-5 This option (option code A) must be selected when Modbus protocol type (Output signal code -M) is selected.	A
Oil-prohibited use <sup>*2</sup>	Degrease cleansing treatment		K1
	Degrease cleansing treatment with fluorinated oilfilled capsule. Operating temperature -20 to 80°C (-4 to 176°F)		K2
Oil-prohibited use with dehydrating treatment <sup>*2</sup>	Degrease cleansing and dehydrating treatment		K5
	Degrease cleansing and dehydrating treatment with fluorinated oilfilled capsule. Operating temperature -20 to 80°C (-4 to 176°F)		K6
Capsule fill fluid		Fluorinated oil filled in capsule Operating temperature -20 to 80°C (-4 to 176°F)	K3
Calibration units <sup>*3</sup>	P calibration (psi unit)	(See Table for Span and Range Limits.)	D1
	bar calibration (bar unit)		D3
	M calibration (kgf/cm <sup>2</sup> unit)		D4
Plug option <sup>*22</sup>	Long vent <sup>*4</sup> Total length: 119 mm (standard: 34 mm); Total length when combining with option code K1, K2, K5, and K6: 130 mm. Material: 316 SST		U1
	Without vent and drain plugs		UN
Gold-plated <sup>*2</sup>		Surface of isolating diaphragms are gold plated, effective for hydrogen permeation. Overpressure effects for M and H capsules: ±0.06% of URL	A1
Output limits and failure operation <sup>*5</sup> (for HART protocol type)	Failure alarm down-scale: Output status at CPU failure and hardware error is -2.5%, 3.6 mA DC or less.		C1
	NAMUR NE43 Compliant Output signal limits: 3.8 mA to 20.5 mA	Failure alarm down-scale: Output status at CPU failure and hardware error is -2.5%, 3.6 mA DC or less.	C2
		Failure alarm up-scale: Output status at CPU failure and hardware error is 110%, 21.6 mA or more.	C3
Body option <sup>*6</sup> 	Right side high pressure, without drain and vent plugs		N1
	N1 and Process connection, based on IEC61518 with female thread on both sides of cover flange, with blind kidney flanges on back.		N2
	N2, and Material certificate for cover flange, diaphragm, capsule body, and blind kidney flange		N3
Wired tag plate		316 SST tag plate wired onto transmitter (Tag No.: Maximum. 16 characters.)	N4
Data configuration at factory <sup>*7</sup>	Data configuration for HART communication type	Software damping, Descriptor, Message	CA
	Data configuration for Fieldbus communication type	Software damping	CC
	Data configuration for Modbus communication type	Software damping, Descriptor, Message	CE
PID function <sup>*13</sup>		(For FOUNDATION Fieldbus protocol type) PID control function	LC1
Software downloading function <sup>*13</sup>		(For FOUNDATION Fieldbus protocol type) Based on FOUNDATION Fieldbus Specification(FF-883) Download class: Class1	EE
Advanced diagnostics (For HART or FOUNDATION Fieldbus protocol type)	Multi-sensing process monitoring • Impulse line blockage detection <sup>*16</sup> • Heat trace monitoring	HART protocol type	DG6
		FOUNDATION Fieldbus protocol type <sup>*17</sup>	DG1
European Pressure Equipment Directive <sup>*14</sup>		PED 2014/68/EU Category III, Module H, type of equipment: Pressure accessory-vessel, Type of fluid: Liquid and Gas, Group of fluid: 1 and 2 Lower limit of ambient and process temperature: -29°C	PE3

Item	Description	Code
Material certificate*8	Cover flange *9	M01
	Cover flange, Process connector *10	M11
	Cover flange, Diaphragm, Capsule body*9*23	MA1
	Cover flange, Process connector, Diaphragm, Capsule body *10*23	MC1
	Cover flange, Bolt and Nut for cover flange, Diaphragm, Capsule body, Vent and Drain plug, Vent screw, Capsule gasket*9*21*22	MG1
	Cover flange, Process connector, Bolt and nut for cover flange, Bolt for process connector, Diaphragm, Capsule body, Vent and Drain plug, Vent screw, Capsule gasket*10*21*22	MH1
Pressure test/ Leak test certificate*11	Test Pressure: 16 MPa(2300 psi)*18	Nitrogen(N2) Gas*12
	Test Pressure: 25 MPa(3600 psi)*19	Retention time: one minute
		T12
		T13

- \*1: Not applicable with color or coating change option.
- \*2: Applicable for Wetted parts material code S.
- \*3: The unit of MWP (Max. working pressure) on the name plate of a housing is the same unit as specified by option codes D1, D3, and D4.
- \*4: Applicable for vertical impulse piping type (Installation code 7) and Wetted parts material code S.
- \*5: Applicable for Output signal codes -E and -J. The hardware error indicates faulty amplifier or capsule.
- \*6: Applicable for Wetted parts material code S; Process connection codes 3, 4, and 5; Installation code 9; and Mounting bracket code N. Process connection faces on the other side of zero adjustment screw.
- \*7: Also see 'Ordering Information'.
- \*8: Material traceability certification, per EN 10204 3.1B.
- \*9: Applicable for Process connections codes 0 and 5.
- \*10: Applicable for Process connections codes 1, 2, 3, and 4.
- \*11: The unit on the certificate is always Pa unit regardless of selection of option code D1, D3 or D4.
- \*12: Dry nitrogen gas is used for oil-prohibited use (option codes K1, K2, K5, and K6).
- \*13: Applicable for Output signal code -F.
- \*14: Applicable for Measurement span codes M and H. If compliance with category III is needed, specify this code.
- \*15: 316 or 316L SST. The specification is included in Amplifier code 2.
- \*16: The change of pressure fluctuation is monitored and then detects the impulse line blockage. Refer to TI 01C25A31-01E for detailed technical information required for using this function.
- \*17: This option code must be specified with option code EE.
- \*18: Applicable for Capsule code L.
- \*19: Applicable for Capsule codes M and H.
- \*20: Not applicable with amplifier housing code 2.
- \*21: Not applicable with plug option code UN.
- \*22: Not applicable with option code N1, N2 and N3.
- \*23: Applicable for option code UN and N1.



**■ DIMENSIONS**

Unit: mm (approx.inch)

● **Vertical Impulse Piping Type (Installation code 7)**

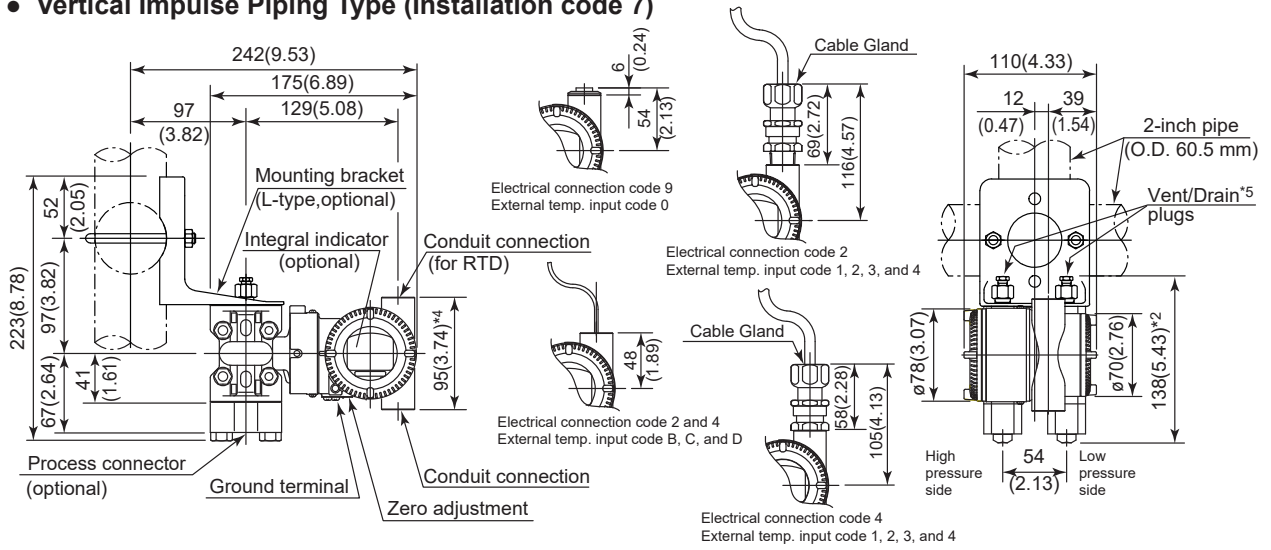

● **Horizontal Impulse Piping Type (Installation code 9)**

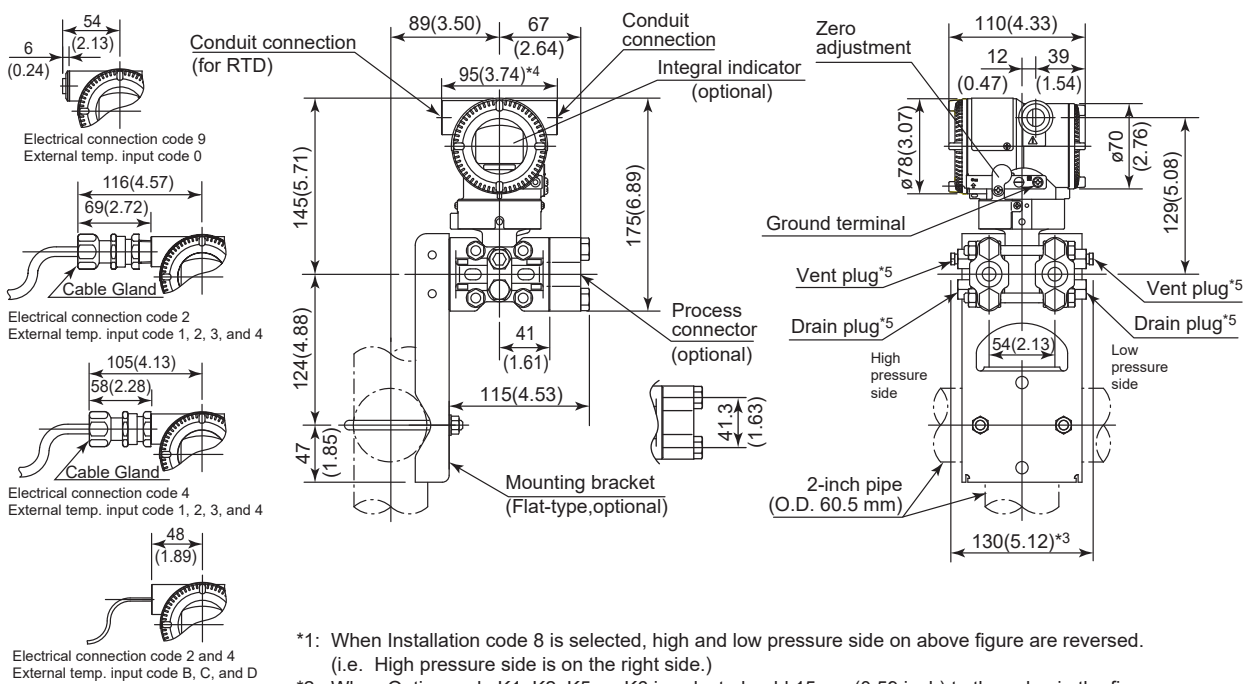

Electrical connection code 2 and 4  
External temp. input code B, C, and D

- \*1: When Installation code 8 is selected, high and low pressure side on above figure are reversed. (i.e. High pressure side is on the right side.)
- \*2: When Option code K1, K2, K5, or K6 is selected, add 15 mm(0.59 inch) to the value in the figure.
- \*3: When Option code K1, K2, K5, or K6 is selected, add 30 mm(1.18 inch) to the value in the figure.
- \*4: When electrical connection code 7 or C is selected, a blind plug is protruded upto 8 mm(0.31 inch) from the conduit connection.
- \*5: When option code /UN is specified, Vent/drain holes and plugs are not applicable.

F05E.ai

Unit: mm (approx.inch)

● Bottom Process Connection Type (Installation code B)

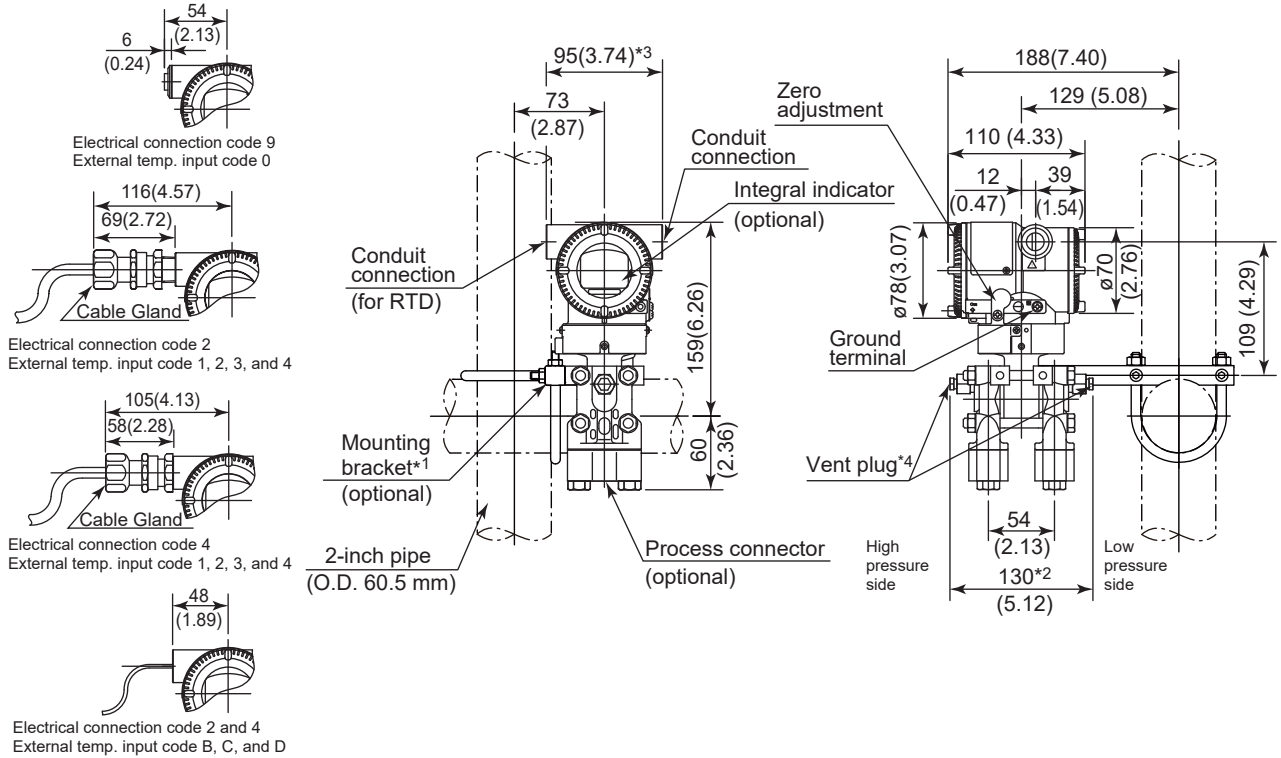

- \*1: A transmitter with SST housing is not applicable for mounting to horizontal 2-inch pipe.
- \*2: When Option code K1, K2, K5, or K6 is selected, add 30 mm (1.18 inch) to the value in the figure.
- \*3: When electrical connection code 7 or C is selected, a blind plug is protruded upto 8 mm (0.31 inch) from the conduit connection.
- \*4: When option code /UN is specified, vent holes and plugs are not applicable.

● Terminal Configuration

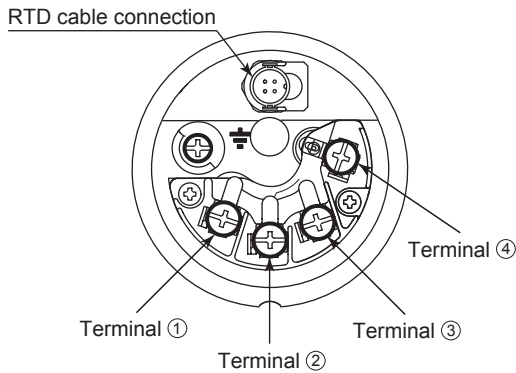

● Terminal Wiring (HART and FOUNDATION Fieldbus protocol types)

SUPPLY	+	①	Power supply and output terminals
	-	②	
CHECK	+	③	External indicator (ammeter) terminals *1*2
	-	②	
PULSE	+	④	Pulse or status contact output terminals *2
	-	②	
			⊥ Ground terminal

\*1: When using an external indicator or check meter, the internal resistance must be 10Ω or less.

\*2: Not available for FOUNDATION Fieldbus communication type.

● Terminal Wiring (Modbus protocol type)

SUPPLY	+	①	Power supply terminals
	-	②	
MODBUS	A	③	Modbus communication (RS-485) terminals
	B	④	
			⊥ Ground terminal

F06.ai

• Wiring Example for Analog Output and Status/Pulse Output (for HART Protocol type)

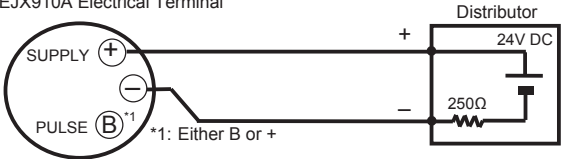
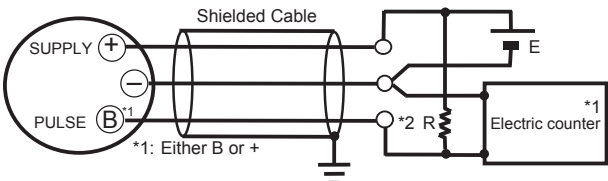
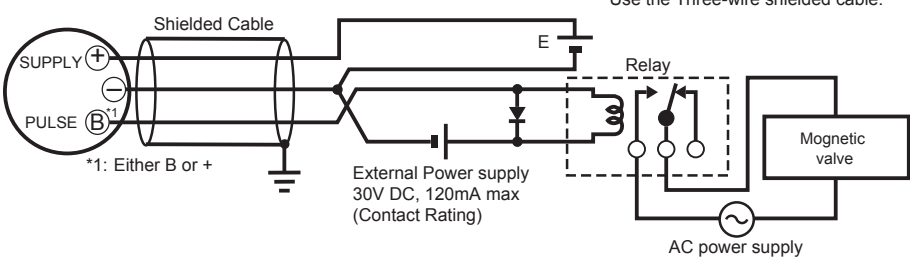
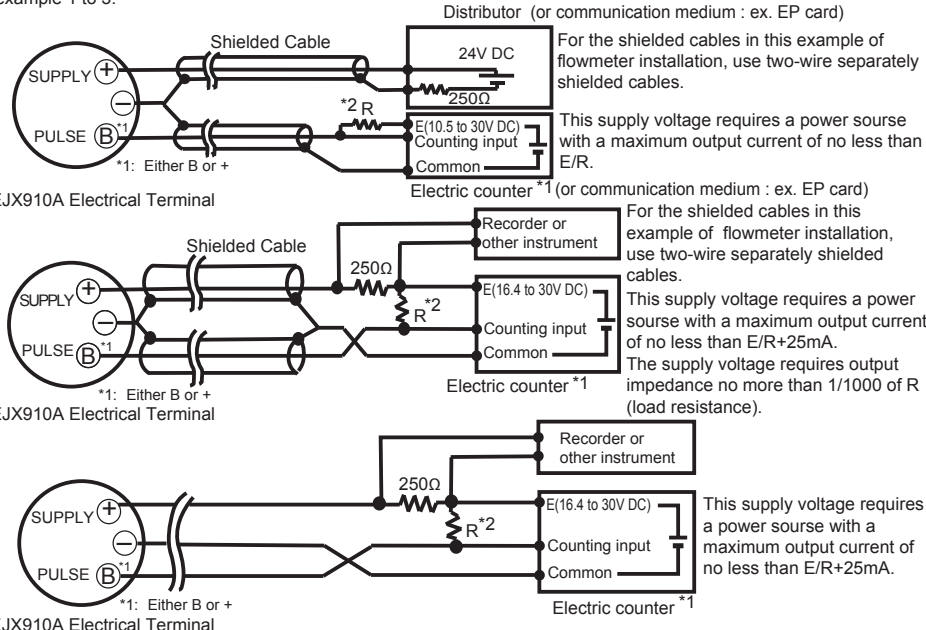
Connection	Description
<p><b>Analog Output</b></p> <p>In this case, Communication is possible (up to a distance of 2km when a CEV cable is used.)</p>	<p>EJX910A Electrical Terminal</p>  <p>Distributor</p> <p>24V DC</p> <p>250Ω</p> <p>SUPPLY (+)</p> <p>PULSE (B)<sup>*1</sup></p> <p>*1: Either B or +</p>
<p><b>Pulse Output</b></p> <p>In this case, No communication is possible.</p>	<p>EJX910A Electrical Terminal</p> <p>Shielded Cable</p>  <p>SUPPLY (+)</p> <p>PULSE (B)<sup>*1</sup></p> <p>*1: Either B or +</p> <p>250Ω</p> <p>E</p> <p>Electric counter<sup>*1</sup></p> <p>Use the Three-wire shielded cable.</p>
<p><b>Status Output</b></p> <p>In this case, No communication is possible.</p>	<p>EJX910A Electrical Terminal</p> <p>Shielded Cable</p>  <p>SUPPLY (+)</p> <p>PULSE (B)<sup>*1</sup></p> <p>*1: Either B or +</p> <p>External Power supply 30V DC, 120mA max (Contact Rating)</p> <p>Relay</p> <p>Magnetic valve</p> <p>AC power supply</p> <p>Use the Three-wire shielded cable.</p>
<p><b>Simultaneous Analog -Pulse Output<sup>*3</sup></b></p> <p>Example 1 In this case, Communication is possible (up to a distance of 2km when a CEV cable is used).</p> <p>Example 2 In this case, Communication is possible (up to a distance of 200m when a CEV cable is used) and R = 1kΩ).</p> <p>Example 3 In this case, No communication is possible (when shielded cable is not used).</p>	<p>When analog and pulse output are used, the length of communication line is subjected to wiring conditions. Refer to example 1 to 3.</p> <p>Distributor (or communication medium : ex. EP card)</p>  <p>Shielded Cable</p> <p>SUPPLY (+)</p> <p>PULSE (B)<sup>*1</sup></p> <p>*1: Either B or +</p> <p>24V DC</p> <p>250Ω</p> <p>E(10.5 to 30V DC)</p> <p>Counting input</p> <p>Common</p> <p>Electric counter<sup>*1</sup> (or communication medium : ex. EP card)</p> <p>Recorder or other instrument</p> <p>250Ω</p> <p>E(16.4 to 30V DC)</p> <p>Counting input</p> <p>Common</p> <p>Electric counter<sup>*1</sup></p> <p>Recorder or other instrument</p> <p>250Ω</p> <p>E(16.4 to 30V DC)</p> <p>Counting input</p> <p>Common</p> <p>Electric counter<sup>*1</sup></p> <p>For the shielded cables in this example of flowmeter installation, use two-wire separately shielded cables.</p> <p>This supply voltage requires a power source with a maximum output current of no less than E/R.</p> <p>For the shielded cables in this example of flowmeter installation, use two-wire separately shielded cables.</p> <p>This supply voltage requires a power source with a maximum output current of no less than E/R+25mA.</p> <p>The supply voltage requires output impedance no more than 1/1000 of R (load resistance).</p> <p>This supply voltage requires a power source with a maximum output current of no less than E/R+25mA.</p>
<p><b>The range of load resistance R for the pulse output.</b></p>	<p>The load resistance of pulse output should be used to 1kΩ, 2W.</p> <p>If no translation of the pulse output possible by the cable length or the frequency of the pulse output, the load resistance should be selected by calculation as shown below.</p> $\frac{E (V)}{120} \leq R (k\Omega) \leq \frac{0.1}{C (\mu F) \times f (kHz)}$ <p>Example of CEV cable capacitance = 0.1μF/km</p> $P (mW) = \frac{E^2 (V)}{R (k\Omega)}$ <p>Where E = Supply voltage (V) f = Frequency of pulse output (kHz) R = Value of load resistance (kΩ) C = Cable capacitance (μF) P = Power ratio of the load resistance (mW)</p>

\*1: To avoid the influence of external noise, use an electric counter which fits to the pulse frequency.  
 \*2: Resistor is not necessary in case of an electric counter which can receive contact pulse signal directly.  
 \*3: When using analog and pulse output simultaneously, the HART communication may be influenced by noise comparing analog output only. Take countermeasure for noise shown above, e.g. use shield cable etc.

**< Ordering Information for HART protocol type >**

Specify the following when ordering.

1. Model, suffix codes, and option codes
2. Calibration range and units
  - 1) Calibration range can be specified with range value specifications up to 5 digits (excluding any decimal point) for low or high range limits within the range of –32000 to 32000.  
When reverse range is designated, specify Lower Range Value (LRV) as greater than Upper Range Value (URV).
  - 2) Specify unit from the tables “Calibration Units for HART protocol type”
3. Static pressure is selected from gauge pressure or absolute pressure.
4. TAG NO (if required)  
Specified characters (up to 22 characters, or 16 characters when /N4 is specified) are engraved on the stainless steel tag plate fixed on the terminal box.
5. SOFTWARE TAG (if required)  
Specified characters\*1 are set as “Tag” (the first 8 characters) and “Long tag”\*2 (32 characters) in the amplifier memory.  
When the “SOFTWARE TAG” is not specified, specified “TAG NO” is set as “Tag” (the first 8 characters) and “Long tag”\*2 (22 characters) in the amplifier memory.  
\*1: Output signal code “E” (HART 5): up to 8 characters are specified  
Output signal code “J” (HART 5/HART 7): up to 32 characters are specified  
\*2: Applicable only for HART 7
6. Other factory configurations (if required)  
Specifying option code CA will allow further configuration at factory.  
Following are configurable items and setting range.
  - 1) Descriptor (up to 16 characters)
  - 2) Message (up to 30 characters)
  - 3) Software damping in second (0.00 to 100.00)
7. When the output signal code is “J”, specify the HART protocol revision “5” or “7”.

**Table 11. Factory Setting for HART protocol type**

Parameter	Default value	Description
Tag number	—	As specified in order
Flow unit	kg/h	Valid when Measurement Function Code B is specified. Standard flow configuration Fluid: N2 Primary element type: ISO5167-1 1991 Orifice Corner Taps Upstream internal pipe diameter = 0.0527 m (Carbon Steel) Diameter of primary device = 0.03162 m (SUS304) Operating Pressure range = 0.1 to 1 MPa abs Operating Temperature range = 0 to 50°C
Flow LRV	0	
Flow URV	1000	
Flow Damping *1	0.00 s	
DP unit	kPa	
DP LRV	0	As specified in order
DP URV	Max.span	
DP Damping *1	2.00 s	As specified in order
SPA/G Selection	Absolute	As specified in order
SP unit	MPa	Selectable from Table 14. Static Pressure Unit
SP LRV	0	As specified in order
SP URV	16	
SP Damping *1	1.00 s	As specified in order
ET unit	°C	Selectable from Table 15. Temperature Unit
ET LRV	–200	As specified in order
ET URV	850	
ET Damping *1	1.00 s	As specified in order
Fixed Temperature	20°C (68°F)	When External Temperature Input Code 0 is specified.
Output signal	DP	When Measurement Function Code A is specified.
	Flow	When Measurement Function Code B is specified.
Display setting	DP and unit	When Measurement Function Code A is specified.
	Flow and unit	When Measurement Function Code B is specified.

\*1: To specify these items at factory, option code CA is required.

**Calibration Units for HART protocol type**

**Table 12-1. Mass Flow Unit**

Unit	LCD	Communication
grams per second	g/s	←
grams per minute	g/m	g/min
grams per hour	g/h	←
kilograms per second	kg/s	←
kilograms per minute	kg/m	kg/min
kilograms per hour	kg/h	←
kilograms per day	kg/d	←
metric tons per minute	t/m	t/min
metric tons per hour	t/h	←
metric tons per day	t/d	←
pounds per second	lb/s	←
pounds per minute	lb/m	lb/min
pounds per hour	lb/h	←
pounds per day	lb/d	←
short tons per minute	STon/m	STon/min
short tons per hour	STon/h	←
short tons per day	STon/d	←
long tons per hour	LTon/h	←
long tons per day	LTon/d	←

**Table 12-2. Normal-Standard Volume Flow Unit**

Unit	LCD	Communication
normal cubic meter per hour	Nm <sup>3</sup> /h	←
normal liter per hour	NL/h	←
standard cubic feet per minute	SCFM	←
standard liter per hour	SL/h	←
standard liter per minute	SL/m	SL/min
standard liter per second	SL/s	←
normal cubic meter per day	Nm <sup>3</sup> /d	←
standard cubic feet per day	SCFD	←
standard cubic feet per hour	SCFH	←
standard cubic feet per second	SCFS	←
standard cubic meter per day	Sm <sup>3</sup> /d	←
standard cubic meter per hour	Sm <sup>3</sup> /h	←
thousand standard cubic feet per day	MSCFD	←
million standard cubic feet per day	MMSCFD	←

**Table 12-3. Volume Flow Unit**

Unit	LCD	Communication
cubic feet per minute	CFM	←
gallons per minute	GPM	←
liters per minute	L/m	L/min
imperial gallons per minute	IGal/m	Impgal/min
cubic meter per hour	M <sup>3</sup> /h	←
gallons per second	gal/s	←
million gallons per day	Mgal/d	←
liters per second	L/s	←
million liters per day	ML/d	←
cubic feet per second	CFS	←
cubic feet per day	ft <sup>3</sup> /d	←
cubic meters per second	M <sup>3</sup> /s	←
cubic meters per day	M <sup>3</sup> /d	←
imperial gallons per hour	IGal/h	Impgal/h
imperial gallons per day	IGal/d	Impgal/d
cubic feet per hour	CFH	←
cubic meters per minute	m <sup>3</sup> /m	m <sup>3</sup> /min
barrels per second	bbl/s	←
barrels per minute	bbl/m	bbl/min
barrels per hour	bbl/h	←
barrels per day	bbl/d	←
gallons per hour	gal/h	←
imperial gallons per second	IGal/s	Impgal/s
liters per hour	L/h	←
gallons per day	gal/d	←



**Table 13. Pressure Unit**

Unit	LCD	Communication
mmH2O@4C	mmH2O	←
mmH2O@68F	mmH2O	←
mmHg	mmHg	←
Torr	Torr	←
MPa	MPa	←
kPa	kPa	←
Pa	Pa	←
mbar	mbar	←
bar	bar	←
gf/cm2	gf/cm2	←
kgf/cm2	kgf/cm2	←
inH2O@4C	inH2O	←
inH2O@68F	inH2O	←
inHg	inHg	←
ftH2O@4C	ftH2O	←
psi	psi	←
atm	atm	←
ftH2O@68F	ftH2O	←
hPa	hPa	←

**Table 14. Static Pressure Unit**

Unit	LCD/ Communication	When abs is selected	
		LCD	Communication
mmH2O@4C	mmH2O	mmH2OA	mmH2O
mmH2O@68F	mmH2O	mmH2OA	mmH2O
mmHg@0C	mmHg	mmHgA	mmHg
Torr	Torr	TorrA	Torr
MPa	MPa	MPaA	MPa
kPa	kPa	kPaA	kPa
Pa	Pa	PaA	Pa
mbar	mbar	mbarA	mbar
bar	bar	barA	bar
gf/cm2	gf/cm2	g/cm2A	g/cm2
kgf/cm2	kgf/cm2	kg/cm2A	kg/cm2
inH2O@4C	inH2O	inH2OA	inH2O
inH2O@68F	inH2O	inH2OA	inH2O
inHg@0C	inHg	inHgA	inHg
ftH2O@4C	ftH2O	ftH2OA	ftH2O
psi	psi	psiA	psi
atm	atm	atmA	atm
ftH2O@68F	ftH2O	ftH2OA	ftH2O
hPa	hPa	hPaA	hPa

**Table 15. Temperature Unit**

Unit	LCD/Communication
°C	deg C
°F	deg F
Kelvin	K

**Table 16. Total Flow Unit**

Unit	LCD/Communication
grams	g
kilograms	kg
metric tons	t
pounds	lb
short tons	STon
long tons	LTon
ounce	oz
gallons	gal
liters	L
imperial gallons	Impgal
cubic meters	m3
barrels	bbl
cubic yards	yd3
cubic feet	ft3
cubic inches	in3
normal cubic meter	Nm3
normal liter	NL
standard cubic feet	SCF

**< Ordering Information for FOUNDATION Fieldbus protocol type >**

Specify the following when ordering.

1. Model, suffix codes, and option codes
2. Calibration range and units for Differential pressure, Static pressure and external temperature
  - 1) Calibration range can be specified with range value specifications up to 5 digits (excluding any decimal point) for low or high range limits within the range of –32000 to 32000. When reverse range is designated, specify Lower Range Value (LRV) as greater than Upper Range Value (URV).
  - 2) Specify unit. See Table 17 for settable unit at factory.
3. Static pressure is selected from gauge pressure or absolute pressure.
4. Tag Number (if required)  
Specify software tag (PD\_TAG) up to 32 characters to be written on the amplifier memory and Tag number up to 22 characters (or 16 characters when /N4 is specified) to be engraved on the tag plate separately.
5. Output mode (AI1 L\_TYPE) ;  
Select one from 'Direct', 'indirect Linear' or 'indirect SQRT' for output mode of AI1(Differential pressure).
6. Output scale and unit (AI1 OUT\_SCALE);  
This setting is used for Indicator and output of AI1 block for Differential pressure. The scale range can be specified with range limit specifications up to 5 digit (excluding any decimal point) for low and high range limits within the range of –32000 to 32000. When AI1 L\_TYPE is Direct, these setting does not affect the output of AI1 block.
7. Specify Node address in hexadecimal.
8. Select 'BASIC' or 'LINK MASTER' for Operation Functional Class.
9. Other factory configurations (if required)  
Specifying option code CC will allow further configuration at factory.  
Following is configurable item and setting range:  
Software damping in second (0.00 to 100.00)

**Table 17. Factory Setting for FOUNDATION Fieldbus protocol type**

Parameter	Default value	Description
Tag number	—	As specified in order
Software Tag (PD_TAG)	FT1001	As specified in order
Flow unit (XD_SCALE of AI4)	kg/h	Valid when Measurement Function Code B is specified. Standard flow configuration Fluid: N2 Primary element type: ISO5167-1 1991 Orifice Corner Taps Upstream internal pipe diameter = 0.0527 m (Carbon Steel) Diameter of primary device = 0.03162 m (SUS304) Operating Pressure range = 0.1 to 1 MPa abs Operating Temperature range = 0 to 50°C
Flow LRV (XD_SCALE of AI4)	0	
Flow URV (XD_SCALE of AI4)	1000	
Flow Damping *1	0.00 s	
DP unit (XD_SCALE of AI1)	kPa	
DP LRV (XD_SCALE of AI1)	0	As specified in order
DP URV (XD_SCALE of AI1)	Max.span	
DP Damping *1	2.00 s	As specified in order
SP A/G selection	Absolute	Absolute or gauge, as specified in order
SP unit (XD_SCALE of AI2)	MPa	See Description for 'DP unit (XD_SCALE of AI1).'
SP LRV (XD_SCALE of AI2)	0	As specified in order
SP URV (XD_SCALE of AI2)	16	
SP Damping *1	1.00 s	As specified in order
ET unit (XD_SCALE of AI3)	°C	Selectable from °C, °F or Kelvin.
ET LRV (XD_SCALE of AI3)	–200	As specified in order
ET URV (XD_SCALE of AI3)	850	
ET Damping *1	1.00 s	As specified in order
Fixed Temperature	20°C (68°F)	When External Temperature Input Code 0 is specified.
Output signal	DP, SP, ET	When Measurement Function Code A is specified.
	Flow, DP, SP, ET	When Measurement Function Code B is specified.
Display setting	DP and unit	When Measurement Function Code A is specified.
	Flow and unit	When Measurement Function Code B is specified.
Node Address	'0xF5'	As specified in order
Operation Functional Class	'BASIC'	As specified in order

\*1: To specify these items at factory, option code CC is required.

**Calibration Units for FOUNDATION Fieldbus protocol type**

**Table 18. Temperature Unit**

INDEX	UNIT	LCD
1000	K	Kelvin
1001	°C	deg C
1002	°F	deg F

**Table 19-1. Pressure unit (1)**

INDEX	UNIT	LCD
1130	Pa	Pa
1131	GPa	GPa
1132	MPa	MPa
1133	kPa	kPa
1134	mPa	mPa
1135	µPa	uPa
1136	hPa	hPa
1137	bar	bar
1138	mbar	mbar
1139	torr	torr
1140	atm	atm
1141	psi	psi
1142	psia	psia
1143	psig	psig
1144	g/cm2	g/cm2
1145	kg/cm2	kg/cm2
1146	inH2O	inH2O
1147	inH2O(4°C)	inH2O
1148	inH2O(68°F)	inH2O
1149	mmH2O	mmH2O
1150	mmH2O(4°C)	mmH2O
1151	mmH2O(68°F)	mmH2O
1152	ftH2O	ftH2O
1153	ftH2O(4°C)	ftH2O
1154	ftH2O(68°F)	ftH2O
1155	inHg	inHg
1156	inHg(0°C)	inHg
1157	mmHg	mmHg
1158	mmHg(0°C)	mmHg

**Table 19-2. Pressure unit (2)**

INDEX	UNIT	LCD
1541	Paa	Paa
1542	Pag	Pag
1543	GPaa	GPaa
1544	GPag	GPag
1545	MPaa	MPaa
1546	MPag	MPag
1547	kPaa	kPaa
1548	kPag	kPag
1549	mPaa	mPaa
1550	mPag	mPag
1551	µPaa	uPaa
1552	µPag	uPag
1553	hPaa	hPaa
1554	hPag	hPag
1555	g/cm2a	g/cm2a
1556	g/cm2g	g/cm2g
1557	kg/cm2a	kg/cm2a
1558	kg/cm2g	kg/cm2g
1559	inH2Oa	inH2Oa
1560	inH2Og	inH2Og
1561	inH2Oa(4°C)	inH2Oa
1562	inH2Og(4°C)	inH2Og
1563	inH2Oa(68°F)	inH2Oa
1564	inH2Og(68°F)	inH2Og
1565	mmH2Oa	mmH2Oa
1566	mmH2Og	mmH2Og
1567	mmH2Oa(4°C)	mmH2Oa
1568	mmH2Og(4°C)	mmH2Og
1569	mmH2Oa(68°F)	mmH2Oa
1570	mmH2Og(68°F)	mmH2Og
1571	ftH2Oa	ftH2Oa
1572	ftH2Og	ftH2Og
1573	ftH2Oa(4°C)	ftH2Oa
1574	ftH2Og(4°C)	ftH2Og
1575	ftH2Oa(68°F)	ftH2Oa
1576	ftH2Og(68°F)	ftH2Og
1577	inHga	inHga
1578	inHgg	inHgg
1579	inHga(0°C)	inHga
1580	inHgg(0°C)	inHgg
1581	mmHga	mmHga
1582	mmHgg	mmHgg
1583	mmHga(0°C)	mmHga
1584	mmHgg(0°C)	mmHgg
1590	Barg	Barg
1591	mBarg	mBarg
1597	Bara	Bara

**Table 20-1. Mass Flow Unit**

INDEX	UNIT	LCD
1318	g/s	g/s
1319	g/min	g/m
1320	g/h	g/h
1322	kg/s	kg/s
1323	kg/min	kg/m
1324	kg/h	kg/h
1325	kg/d	kg/d
1327	t/min	t/m
1328	t/h	t/h
1329	t/d	t/d
1330	lb/s	lb/s
1331	lb/min	lb/m
1332	lb/h	lb/h
1333	lb/d	lb/d
1335	STon/min	STon/m
1336	STon/h	STon/h
1337	STon/d	STon/d
1340	LTon/h	LTon/h
1341	LTon/d	LTon/d

**Table 20-2. Normal-Standard Volume Flow Unit**

INDEX	UNIT	LCD
1360	SCFM	SCFM
1361	SCFH	SCFH
1524	Nm3/h	Nm3/h
1525	Nm3/d	Nm3/d
1529	Sm3/h	Sm3/h
1530	Sm3/d	Sm3/d
1534	NL/h	NL/h
1537	SL/s	SL/s
1538	SL/h	SL/h
1539	SL/m	SL/m
1598	MSCFD	MSCFD
1599	MMSCFD	MMSCFD
65520	SCFS	SCFS
65521	SCFD	SCFD

**Table 20-3. Volume Flow Unit**

INDEX	UNIT	LCD
1347	m3/s	m3/s
1348	m3/min	m3/m
1349	m3/h	m3/h
1350	m3/d	m3/d
1351	L/s	L/s
1352	L/min	L/m
1353	L/h	L/h
1355	ML/d	ML/d
1356	CFS	CFS
1357	CFM	CFM
1358	CFH	CFH
1359	ft3/d	ft3/d
1362	gal/s	gal/s
1363	GPM	GPM
1364	gal/h	gal/h
1365	gal/d	gal/d
1366	Mgal/d	Mgal/d
1367	ImpGal/s	IGal/s
1368	ImpGal/min	IGal/m
1369	ImpGal/h	IGal/h
1370	ImpGal/d	IGal/d
1371	bb/s	bb/s
1372	bb/min	bb/m
1373	bb/h	bb/h
1374	bb/d	bb/d

**< Ordering Information for Modbus protocol type >**

Specify the following when ordering.

1. Model, suffix codes, and option codes
2. Calibration range and units
  - 1) Calibration range can be specified with range value specifications up to 5 digits (excluding any decimal point) for low or high range limits within the range of –32000 to 32000.  
When reverse range is designated, specify Lower Range Value (LRV) as greater than Upper Range Value (URV).
  - 2) Specify unit from the tables “Calibration Units for Modbus protocol type”
3. Static pressure is selected from gauge pressure or absolute pressure.
4. TAG NO (if required)  
Specified characters (up to 22 characters, or 16 characters when /N4 is specified) are engraved on the stainless steel tag plate fixed on the terminal box.
5. SOFTWARE TAG (if required)  
Specified characters (up to 32 characters) are set as “Tag” (the first 8 characters) and “Long tag” (32 characters) in the amplifier memory.  
When the “SOFTWARE TAG” is not specified, specified “TAG NO” is set as “Tag” (the first 8 characters) and “Long tag” (22 characters) in the amplifier memory.
6. Other factory configurations (if required)  
Specifying option code CE will allow further configuration at factory.  
Following are configurable items and setting range.
  - 1) Descriptor (up to 16 characters)
  - 2) Message (up to 30 characters)
  - 3) Software damping in second (0.00 to 100.00)

**Table 21. Factory Setting for Modbus protocol type**

Parameter	Default value	Description
Tag number	—	As specified in order
DP unit	kPa	Selectable from Table 22. Pressure Unit
DP LRV	0	As specified in order
DP URV	Max.span	
DP Damping *1	2.00 s	As specified in order
SP A/G Selection	Absolute	As specified in order
SP unit	MPa	Selectable from Table 23. Static Pressure Unit
SP LRV	0	As specified in order
SP URV	16	
SP Damping *1	1.00 s	As specified in order
ET unit	°C	Selectable from Table 24. Temperature Unit
ET LRV	–200	As specified in order
ET URV	850	
ET Damping *1	1.00 s	As specified in order
Fixed Temperature	20°C (68°F)	When External Temperature Input Code 0 is specified.
Display setting	DP and unit	

\*1: To specify these items at factory, option code CE is required.



**Calibration Units for Modbus protocol type**

**Table 22. Pressure Unit**

Unit	LCD	Communication
mmH2O@4C	mmH2O	←
mmH2O@68F	mmH2O	←
mmHg	mmHg	←
Torr	Torr	←
MPa	MPa	←
kPa	kPa	←
Pa	Pa	←
mbar	mbar	←
bar	bar	←
gf/cm2	gf/cm2	←
kgf/cm2	kgf/cm2	←
inH2O@4C	inH2O	←
inH2O@68F	inH2O	←
inHg	inHg	←
ftH2O@4C	ftH2O	←
psi	psi	←
atm	atm	←
ftH2O@68F	ftH2O	←
hPa	hPa	←

**Table 23. Static Pressure Unit**

Unit	LCD/ Communication	When abs is selected	
		LCD	Communication
mmH2O@4C	mmH2O	mmH2OA	mmH2O
mmH2O@68F	mmH2O	mmH2OA	mmH2O
mmHg@0C	mmHg	mmHgA	mmHg
Torr	Torr	TorrA	Torr
MPa	MPa	MPaA	MPa
kPa	kPa	kPaA	kPa
Pa	Pa	PaA	Pa
mbar	mbar	mbarA	mbar
bar	bar	barA	bar
gf/cm2	gf/cm2	g/cm2A	g/cm2
kgf/cm2	kgf/cm2	kg/cm2A	kg/cm2
inH2O@4C	inH2O	inH2OA	inH2O
inH2O@68F	inH2O	inH2OA	inH2O
inHg@0C	inHg	inHgA	inHg
ftH2O@4C	ftH2O	ftH2OA	ftH2O
psi	psi	psiA	psi
atm	atm	atmA	atm
ftH2O@68F	ftH2O	ftH2OA	ftH2O
hPa	hPa	hPaA	hPa

**Table 24. Temperature Unit**

Unit	LCD/Communication
°C	deg C
°F	deg F
Kelvin	K

**< Material Cross Reference >**

ASTM	JIS
316	SUS316
F316	SUSF316
316L	SUS316L
F316L	SUSF316L
304	SUS304
F304	SUSF304
660	SUH660
B7	SNB7
CF-8M	SCS14A

**< Related Instruments >**

FSA120 Flow Configuration Software (FlowNavigator): Refer to GS 01C25R51-01EN  
Power Distributor: Refer to GS 01B04T01-02E or GS 01B04T02-02E

**< Trademarks >**

1. *DP Harp EX*, FieldMate and FlowNavigator are registered trademarks of Yokogawa Electric Corporation.
2. Teflon; Trademark of E.I. DuPont de Nemours & Co.
3. Hastelloy; Trademark of Haynes International Inc.
4. HART®: Registered trademark of the FieldComm Group.
5. AIChE, DIPPR (Design Institute for Physical Properties); Trademarks of American Institute of Chemical Engineers.
6. AGA; Trademark of American Gas Association.
7. FOUNDATION Fieldbus; Trademark of the FieldComm Group.
8. Modbus is a registered trademark of AEG Schneider.

Other company/organization and/or product names are registered trade marks of their respective holders.

**< Information on EU WEEE Directive >**

EU WEEE (Waste Electrical and Electronic Equipment) Directive is only valid in the EU.

This instrument is intended to be sold and used only as a part of equipment which is excluded from WEEE Directive, such as large-scale stationary industrial tools, a large-scale fixed installation and so on, and, therefore, subjected to the exclusion from the scope of the WEEE Directive. The instrument should be disposed of in accordance with local and national legislation/regulations.